

CUCINA ELETTRICA
PER BORDO

MARINE ELECTRIC RANGE

RIQ 2 SERIES

SENZA FORNO
WITHOUT OVEN

IP 44



- PROGETTAZIONE PER ESCLUSIVO IMPIEGO NAVALE
- GRADO DI PROTEZIONE IP44
- COSTRUZIONE ESTREMAMENTE ROBUSTA
- FACILITA' DI MANUTENZIONE
- FACILMENTE PULIBILE
- SMONTABILE PER INSERIMENTO A BORDO
- TOP, RIVESTIMENTO, PIEDI IN ACCIAIO INOX AISI 304
- SUPPORTO PARTICOLARMENTE ROBUSTO CON RIPIANO E ANTIROLLIO TUBOLARE SALDATO
- CAVI PER ALTA TEMPERATURA
- PIANO SPESSORE 2 mm INTERAMENTE SALDATO IN ACCIAIO INOX AISI 304
- STAZZE ANTIROLLIO REGOLABILI E SMONTABILI IN ACCIAIO INOX
- PIASTRE CON RESISTENZE ESTRAIBILI, CON 40 mm DI ISOLANTE
- ALIMENTAZIONE VOLT 115/3/60 - 208/3/50-60 - 230/3/50-60 - 400/3/50 - 415/3/50-60 - 440/3/60 - 460/3/50-60 - 480/3/60
- ALTRI VOLTAGGI A RICHIESTA
- COMBINAZIONI TOP E ULTERIORI INFORMAZIONI VEDI RETRO
- EXCLUSIVELY PROJECTED FOR MARINE USE
- PROTECTION DEGREE IP44
- EXTREMELY STRONG CONSTRUCTION
- QUICK AND EASY MAINTENANCE
- EASY CLEANING
- DEMOUNTABLE FOR INSTALLATION ON BOARD
- AISI 304 S.S. TOP, EXTERNAL COVERING, FEET
- UNDERNEATH HEAVY DUTY STAND WITH WELDED SHELF AND TUBULAR ANTIROLLING BAR
- HIGH TEMPERATURE CABLE
- AISI 304 STAINLESS STEEL 2 mm THICKNESS TOP ENTIRELY WELDED
- ADJUSTABLE AND REMOVABLE STAINLESS STEEL ANTIROLLING BARS
- PLATE HEATING ELEMENT REMOVABLE, WITH 40 mm INSULATION
- RATED VOLTAGE VOLT 115/3/60 - 208/3/50-60 - 230/3/50-60 - 400/3/50 - 415/3/50-60 - 440/3/60 - 460/3/50-60 - 480/3/60
- OTHER VOLTAGE ON REQUEST
- TOP COMBINATION AND MORE INFORMATION SEE OVERLEAF

baratta

MARINE FOOD SERVICE EQUIPMENT

IT - GB	05	15
01-090800-01		

ESEMPI DI COMBINAZIONI TOP – TOP COMBINATIONS EXAMPLE

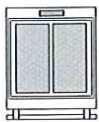

RIQ-20
2 PIASTRE – HOT PLATES 300x610 mm
POTENZA TOTALE – TOTAL POWER Kw 9,6

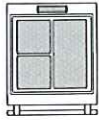

RIQ23-20
2 PIASTRE – HOT PLATES 300x300 mm
1 PIASTRA – HOT PLATE 300x610 mm
POTENZA TOTALE – TOTAL POWER Kw 9,6

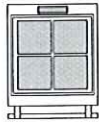

RIQ43-20
4 PIASTRE – HOT PLATES 300x300 mm
POTENZA TOTALE – TOTAL POWER Kw 9,6

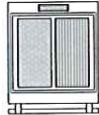

RIQ-201
1 PIASTRA – HOT PLATE 300x610 mm
1 BISTECCHIERA RIGATA 300x610 mm
GROOVED GRIDDLE 300x610 mm
POTENZA TOTALE – TOTAL POWER Kw 9,6

RIQ23-201
2 PIASTRE – HOT PLATES 300x300 mm
1 BISTECCHIERA RIGATA 300x610 mm
GROOVED GRIDDLE 300x610 mm
POTENZA TOTALE – TOTAL POWER Kw 9,6

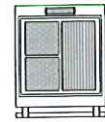

RIQ6-20
1 PIASTRA – HOT PLATE 600x610 mm
POTENZA TOTALE – TOTAL POWER Kw 9,6



RIQ23-20L
2 PIASTRE – HOT PLATES 300x300 mm
1 BISTECCHIERA LISCIA 300x610 mm
SMOOTH GRIDDLE 300x610 mm
POTENZA TOTALE – TOTAL POWER Kw 9,6

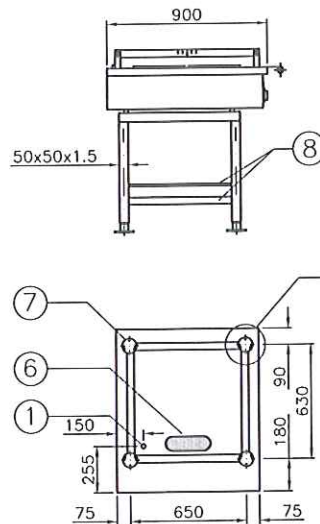
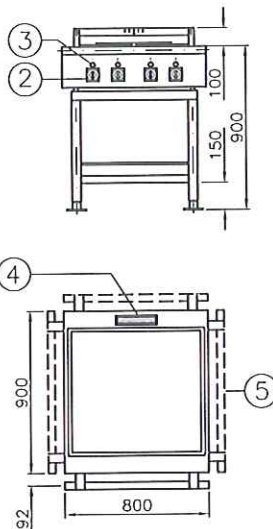
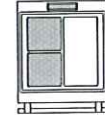

PARTICOLARE PIEDE
FOOT DETAIL

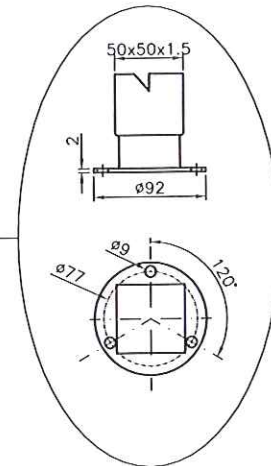

- 1 PASSAGGI STAGNI PER CAVI ELETTRICI
CORD CONNECTORS
- 2 COMMUTATORI PIASTRE*
PLATES DELTA-STAR SWITCHES*
- 3 LAMPADA SPIA
PILOT LAMP
- 4 GRIGLIA DI AEREAZIONE TOP
TOP VENTILATION GRID
- 5 CORRIMANO LATERALE E POST. (A RICHIESTA CON EXTRA COSTO)
REAR AND SIDE HAND RAIL (ON REQUEST WITH EXTRA COST)
- 6 GRIGLIA DI AEREAZIONE FONDO
BOTTOM VENTILATION GRID

- 7 POSIZIONE PER FISSAGGIO PIEDI
FEET FIXING POSITION
 - 8 PIANO SOTTOSTANTE CON ANTIROLLIO TUBOLARE
UNDERNEATH SHELF WITH TUBULAR ANTIROLLING BAR
- GRADO DI PROTEZIONE IP44
PROTECTION DEGREE IP44
- * LA QUANTITA' DEI COMMUTATORI VARIA SECONDO I MODELLI
* QUANTITY OF DELTA STAR WILL BE ACCORDING TO THE MODEL
- ALTRE COMBINAZIONI TOP A RICHIESTA
OTHER TOP COMBINATIONS ON REQUEST

PIASTRE DISPONIBILI PER TOP – AVAILABLE PLATES FOR RANGE TOP

